

# MACHINED RING NEEDLE ROLLER BEARINGS WITH INNER RING

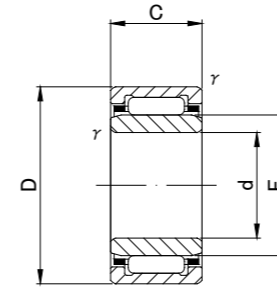

NKI(d ≤ 8)

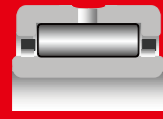
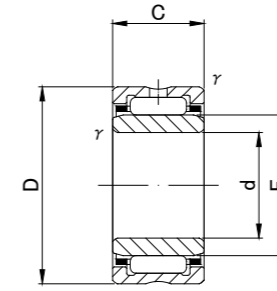

NA49,NA59,NA69(d ≤ 30),NKI

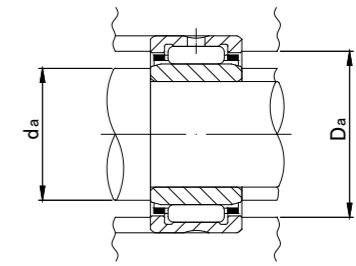

## NA49,NA59,NA69,NA48,NKI TYPE

Shaft Diameter (mm)	Designation					Dimensions (mm)						Standard mounting dimensions (mm)			Basic dynamic load rating	Basic static load rating	Limiting speed*	Mass	Usable bearing designation	
	NA 49	NA 59	NA 69	NA48	NKI	d	D	C	r/s min	F	da		Da	Cr N	Cor N	rpm	g (approx)	OUTER RING	INNER RING	
											MIN	MAX								MAX
5	NA495	—	—	—	—	5	13	10	0.15	7	6.2	6.7	11.8	2 960	2 690	34 000	7.3	RNA495	IR5710	
	—	—	—	—	NKI 5/12	5 <sup>0</sup> <sub>-0.008</sub>	15	12	0.3	8	7	7.7	13	5 100	4 700	32 000	11.9	NK8/12	IR5812	
	—	—	—	—	NKI 5/16	5	15	16	0.3	8	7	7.7	13	7 100	7 300	32 000	16.7	NK8/16	IR5816	
6	NA 496	—	—	—	—	6	15	10	0.15	8	7.2	7.7	13.8	3 900	3 400	32 000	9.1	RNA496	IR6810	
	—	—	—	—	NKI 6/12	6 <sup>0</sup> <sub>-0.008</sub>	16	12	0.3	9	8	8.7	14	5 500	5 300	30 000	13	NK9/12	IR6912	
	—	—	—	—	NKI 6/16	6	16	16	0.3	9	8	8.7	14	7 600	8 200	30 000	17.5	NK9/16	IR6916	
7	NA 497	—	—	—	—	7	17	10	0.15	9	8.2	8.7	15.8	4 500	3 600	30 000	11.2	RNA497	IR7910	
	—	—	—	—	NKI 7/12	7 <sup>0</sup> <sub>-0.008</sub>	17	12	0.3	10	9	9.7	15	5 900	6 000	28 000	14.3	NK10/12	IR71012	
	—	—	—	—	NKI 7/16	7	17	16	0.3	10	9	9.7	15	8 200	9 200	28 000	19.2	NK10/16	IR71016	
8	NA 498	—	—	—	—	8 <sup>0</sup> <sub>-0.008</sub>	19	11	0.2	10	9.2	9.7	17.4	6 200	5 000	28 000	15	RNA498	IR81011	
9	—	—	—	—	NKI 9/12	9	19	12	0.3	12	11	11.5	17	6 600	7 300	26 000	16.7	NK12/12	IR91212	
	—	—	—	—	NKI 9/16	9 <sup>0</sup> <sub>-0.008</sub>	19	16	0.3	12	11	11.5	17	9 200	11 200	26 000	22.5	NK12/16	IR91216	
	NA 499	—	—	—	—	9	20	11	0.3	12	11	11.5	18	6 600	6 300	26 000	16.7	RNA499	IR91211	
10	NA 4900	—	—	—	—	10	22	13	0.3	14	12	13	20	9 200	10 100	24 000	24	RNA4900	IR101413	
	—	—	—	—	NKI 10/16	10 <sup>0</sup> <sub>-0.008</sub>	22	16	0.3	14	12	13	20	11 800	13 700	24 000	30	NK14/16	IR101416	
	—	—	—	—	NKI 10/20	10	22	20	0.3	14	12	13	20	14 800	18 500	24 000	38	NK14/20	IR101420	
12	NA 4901	—	—	—	—	12	24	13	0.3	16	14	15	22	9 700	11 100	23 000	26.5	RNA4901	IR121613	
	—	—	—	—	NKI 12/16	12 <sup>0</sup> <sub>-0.008</sub>	24	16	0.3	16	14	15	22	12 300	15 100	23 000	33.5	NK16/16	IR121616	
	—	—	—	—	NKI 12/20	12	24	20	0.3	16	14	15	22	15 600	20 400	23 000	42.5	NK16/20	IR121620	
	—	—	NA 6901	—	—	12	24	22	0.3	16	14	15	22	17 100	23 000	23 000	44.5	RNA6901	IR121622	

\* Suitable for oil lubrication. In case of grease lubrication, down to 60% of this value.

# MACHINED RING NEEDLE ROLLER BEARINGS WITH INNER RING

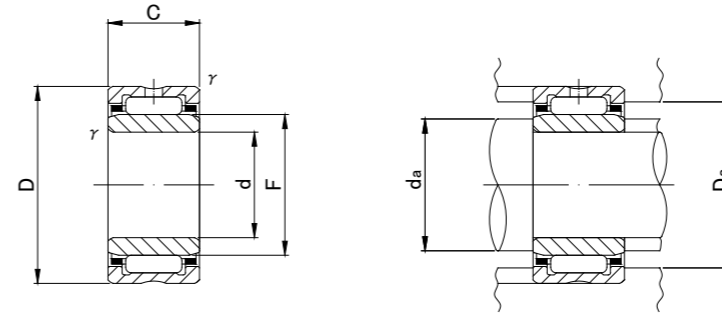
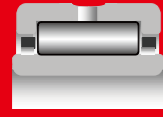

NA49,NA59,NA69(d ≤ 30),NKI

## ■ NA49,NA59,NA69,NA48,NKI TYPE

Shaft Diameter (mm)	Designation					Dimensions (mm)						Standard mounting dimensions (mm)		Basic dynamic load rating	Basic static load rating	Limiting speed*	Mass	Usable bearing designation	
	NA 49	NA 59	NA 69	NA48	NKI	d	D	C	r/s min	F	da		Da	Cr N	Cor N	rpm	g (approx)	OUTER RING	INNER RING
											MIN	MAX							
15	—	—	—	—	NKI 15/16	15	27	16	0.3	19	17	18	25	14 000	18 700	21 000	39.5	NK19/16	IR151916
	—	—	—	—	NKI 15/20	15	27	20	0.3	19	17	18	25	17 700	25 300	21 000	50	NK19/20	IR151920
	NA 4902	—	—	—	—	15 <sup>0</sup> <sub>-0.008</sub>	28	13	0.3	20	17	19	26	10 900	13 800	20 000	35	RNA4902	IR152013
	—	NA 5902	—	—	—	15	28	18	0.3	20	17	19	26	15 700	22 100	20 000	52	RNA5902	IR152018
	—	—	NA 6902	—	—	15	28	23	0.3	20	17	19	26	19 300	28 700	20 000	61	RNA6902	IR152023
17	—	—	—	—	NKI 17/16	17	29	16	0.3	21	19	20	27	14 400	20 000	19 000	43.5	NK21/16	IR172116
	—	—	—	—	NKI 17/20	17	29	20	0.3	21	19	20	27	18 200	27 100	19 000	54	NK21/20	IR172120
	NA 4903	—	—	—	—	17 <sup>0</sup> <sub>-0.008</sub>	30	13	0.3	22	19	21	28	11 800	15 600	18 000	39	RNA4903	IR172213
	—	NA 5903	—	—	—	17	30	18	0.3	22	19	21	28	16 900	24 900	18 000	56	RNA5903	IR172218
	—	—	NA 6903	—	—	17	30	23	0.3	22	19	21	28	20 800	32 500	18 000	67	RNA6903	IR172223
20	—	—	—	—	NKI 20/16	20	32	16	0.3	24	22	23	30	15 300	22 600	17 000	48.5	NK24/16	IR202416
	—	—	—	—	NKI 20/20	20	32	20	0.3	24	22	23	30	19 400	30 500	17 000	61	NK24/20	IR202420
	NA 4904	—	—	—	—	20 <sup>0</sup> <sub>-0.010</sub>	37	17	0.3	25	22	24	35	21 000	25 000	16 000	78.5	RNA4904	IR202517
	—	NA 5904	—	—	—	20	37	23	0.3	25	22	24	35	29 400	38 600	16 000	115	RNA5904	IR202523
	—	—	NA 6904	—	—	20	37	30	0.3	25	22	24	35	35 400	48 800	16 000	136	RNA6904	IR202530
22	—	—	—	—	NKI 22/16	22	34	16	0.3	26	24	25	32	16 300	24 900	15 000	52	NK26/16	IR222616
	—	—	—	—	NKI 22/20	22	34	20	0.3	26	24	25	32	20 600	33 700	15 000	67.5	NK26/20	IR222620
	NA 49/22	—	—	—	—	22 <sup>0</sup> <sub>-0.010</sub>	39	17	0.3	28	24	27	37	21 400	28 800	14 000	87	RNA49/22	IR222817
	—	NA 59/22	—	—	—	22	39	23	0.3	28	24	27	37	29 800	44 400	14 000	134	RNA59/22	IR222823
	—	—	NA 69/22	—	—	22	39	30	0.3	28	24	27	37	36 300	56 900	14 000	152	RNA69/22	IR222830
25	—	—	—	—	NKI 25/20	25	38	20	0.3	29	27	28	36	21 600	37 200	14 000	82	NK29/20	IR252920
	—	—	—	—	NKI 25/30	25	38	30	0.3	29	27	28	36	30 900	59 000	14 000	123	NK29/30	IR252930
	NA 4905	—	—	—	—	25 <sup>0</sup> <sub>-0.010</sub>	42	17	0.3	30	27	29	40	23 700	30 700	13 000	92.5	RNA4905	IR253017
	—	NA 5905	—	—	—	25	42	23	0.3	30	27	29	40	33 200	47 500	13 000	139	RNA5905	IR253023
	—	—	NA 6905	—	—	25	42	30	0.3	30	27	29	40	42 100	64 200	13 000	160	RNA6905	IR253030
28	—	—	—	—	NKI 28/20	28	42	20	0.3	32	30	31	40	25 700	42 200	13 000	96.5	NK32/20	IR283220
	—	—	—	—	NKI 28/30	28	42	30	0.3	32	30	31	40	36 900	67 100	13 000	145	NK32/30	IR283230
	NA 49/28	—	—	—	—	28 <sup>0</sup> <sub>-0.010</sub>	45	17	0.3	32	30	31	43	24 500	32 700	13 000	101	RNA49/28	IR283217
	—	NA 59/28	—	—	—	28	45	23	0.3	32	30	31	43	34 300	50 500	13 000	142	RNA59/28	IR283223
	—	—	NA 69/28	—	—	28	45	30	0.3	32	30	31	43	41 800	64 700	13 000	176	RNA69/28	IR283230
30	—	—	—	—	NKI 30/20	30	45	20	0.3	35	32	34	43	27 000	46 200	11 000	112	NK35/20	IR303520
	—	—	—	—	NKI 30/30	30	45	30	0.3	35	32	34	43	38 600	73 500	11 000	171	NK35/30	IR303530
	NA 4906	—	—	—	—	30 <sup>0</sup> <sub>-0.010</sub>	47	17	0.3	35	32	34	45	25 200	34 700	11 000	106	RNA4906	IR303517
	—	NA 5906	—	—	—	30	47	23	0.3	35	32	34	45	35 200	53 700	11 000	152	RNA5906	IR303523
	—	—	NA 6906	—	—	30	47	30	0.3	35	32	34	45	43 100	69 000	11 000	184	RNA6906	IR303530

\* Suitable for oil lubrication. In case of grease lubrication, down to 60% of this value.

# MACHINED RING NEEDLE ROLLER BEARINGS WITH INNER RING

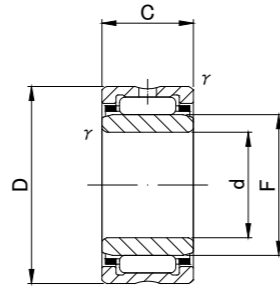
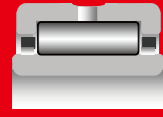

NA49,NA59,NA69(d ≤ 30),NKI

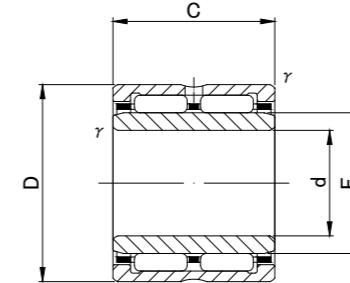

NA69

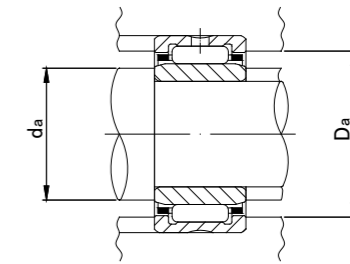

## ■ NA49,NA59,NA69,NA48,NKI TYPE

Shaft Diameter (mm)	Designation					Dimensions (mm)						Standard mounting dimensions (mm)		Basic dynamic load rating	Basic static load rating	Limiting speed*	Mass	Usable bearing designation	
	NA 49	NA 59	NA 69	NA48	NKI	d	D	C	r/s min	F	da		Da	Cr N	Cor N	rpm	g (approx)	OUTER RING	INNER RING
											MIN	MAX							
32	—	—	—	—	<b>NKI 32/20</b>	32	47	20	0.3	37	34	36	45	28 200	50 100	11 000	121	NK37/20	IR323720
	—	—	—	—	<b>NKI 32/30</b>	32	47	30	0.3	37	34	36	45	40 500	79 800	11 000	180	NK37/30	IR323730
	<b>NA 49/32</b>	—	—	—	—	32 <sup>0</sup> <sub>-0.012</sub>	52	20	0.6	40	36	39	48	31 300	47 900	10 000	165	RNA49/32	IR324020
	—	<b>NA 59/32</b>	—	—	—	32	52	27	0.6	40	36	39	48	41 900	69 900	10 000	241	RNA59/32	IR324027
	—	—	<b>NA 69/32</b>	—	—	32	52	36	0.6	40	36	39	48	53 500	95 700	10 000	295	RNA69/32	IR324036
35	—	—	—	—	<b>NKI 35/20</b>	35	50	20	0.3	40	37	39	48	29 400	54 100	10 000	129	NK40/20	IR354020
	—	—	—	—	<b>NKI 35/30</b>	35	50	30	0.3	40	37	39	48	42 300	86 100	10 000	192	NK40/30	IR354030
	<b>NA 4907</b>	—	—	—	—	35 <sup>0</sup> <sub>-0.012</sub>	55	20	0.6	42	39	41	51	32 000	50 200	9 500	178	RNA4907	IR354220
	—	<b>NA 5907</b>	—	—	—	35	55	27	0.6	42	39	41	51	42 900	73 200	9 500	256	RNA5907	IR354227
	—	—	<b>NA 6907</b>	—	—	35	55	36	0.6	42	39	41	51	54 800	100 000	9 500	320	RNA6907	IR354236
38	—	—	—	—	<b>NKI 38/20</b>	38 <sup>0</sup> <sub>-0.012</sub>	53	20	0.3	43	40	42	51	30 500	58 100	9 500	136	NK43/20	IR384320
	—	—	—	—	<b>NKI 38/30</b>	38	53	30	0.3	43	40	42	51	43 700	92 500	9 500	205	NK43/30	IR384330
40	—	—	—	—	<b>NKI 40/20</b>	40	55	20	0.3	45	42	44	53	31 100	60 100	9 000	143	NK45/20	IR404520
	—	—	—	—	<b>NKI 40/30</b>	40	55	30	0.3	45	42	44	53	44 500	95 700	9 000	215	NK45/30	IR404530
	<b>NA 4908</b>	—	—	—	—	40 <sup>0</sup> <sub>-0.012</sub>	62	22	0.6	48	44	47	58	41 600	67 400	8 500	245	RNA4908	IR404822
	—	<b>NA 5908</b>	—	—	—	40	62	30	0.6	48	44	47	58	58 000	103 000	8 500	348	RNA5908	IR404830
	—	—	<b>NA 6908</b>	—	—	40	62	40	0.6	48	44	47	58	71 300	134 400	8 500	440	RNA6908	IR404840
42	—	—	—	—	<b>NKI 42/20</b>	42 <sup>0</sup> <sub>-0.012</sub>	57	20	0.3	47	44	46	55	31 500	62 300	8 500	149	NK47/20	IR424720
	—	—	—	—	<b>NKI 42/30</b>	42	57	30	0.3	47	44	46	55	45 200	99 000	8 500	225	NK47/30	IR424730
45	—	—	—	—	<b>NKI 45/25</b>	45	62	25	0.6	50	49	49.5	58	43 000	85 200	8 000	230	NK50/25	IR455025
	—	—	—	—	<b>NKI 45/35</b>	45	62	35	0.6	50	49	49.5	58	58 100	125 500	8 000	320	NK50/35	IR455035
	<b>NA 4909</b>	—	—	—	—	45 <sup>0</sup> <sub>-0.012</sub>	68	22	0.6	52	49	51	64	43 500	73 400	7 500	285	RNA4909	IR455222
	—	<b>NA 5909</b>	—	—	—	45	68	30	0.6	52	49	51	64	60 700	112 000	7 500	396	RNA5909	IR455230
	—	—	<b>NA 6909</b>	—	—	45	68	40	0.6	52	49	51	64	74 600	147 100	7 500	520	RNA6909	IR455240
50	—	—	—	—	<b>NKI 50/25</b>	50	68	25	0.6	55	54	54.5	64	45 400	94 100	7 500	270	NK55/25	IR505525
	—	—	—	—	<b>NKI 50/35</b>	50	68	35	0.6	55	54	54.5	64	61 300	138 300	7 500	365	NK55/35	IR505535
	<b>NA 4910</b>	—	—	—	—	50 <sup>0</sup> <sub>-0.012</sub>	72	22	0.6	58	54	57	68	46 200	82 100	7 000	295	RNA4910	IR505822
	—	<b>NA 5910</b>	—	—	—	50	72	30	0.6	58	54	57	68	64 400	126 000	7 000	498	RNA5910	IR505830
	—	—	<b>NA 6910</b>	—	—	50	72	40	0.6	58	54	57	68	79 100	163 800	7 000	530	RNA6910	IR505840

\* Suitable for oil lubrication. In case of grease lubrication, down to 60% of this value.

# MACHINED RING NEEDLE ROLLER BEARINGS WITH INNER RING

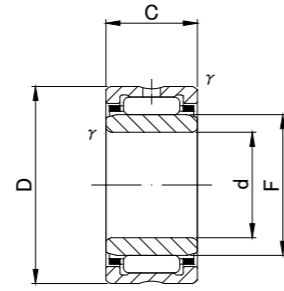
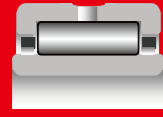

NA49,NA59,NKI

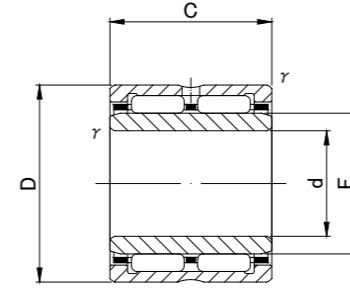

NA69

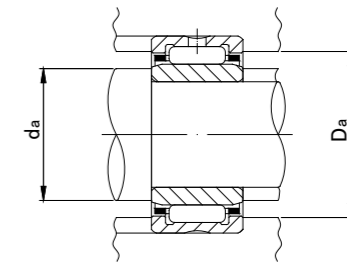

## NA49,NA59,NA69,NA48,NKI TYPE

Shaft Diameter (mm)	Designation					Dimensions (mm)						Standard mounting dimensions (mm)		Basic dynamic load rating	Basic static load rating	Limiting speed*	Mass	Usable bearing designation	
	NA 49	NA 59	NA 69	NA48	NKI	d	D	C	r/s min	F	da		Da	Cr N	Cor N	rpm	g (approx)	OUTER RING	INNER RING
											MIN	MAX							
55	—	—	—	—	NKI 55/25	55	72	25	0.6	60	59	59.5	68	47 500	103 000	6 500	275	NK60/25	IR556025
	—	—	—	—	NKI 55/35	55	72	35	0.6	60	59	59.5	68	64 100	151 000	6 500	380	NK60/35	IR556035
	NA 4911	—	—	—	—	55 <sup>0</sup> <sub>-0.015</sub>	80	25	1	63	60	61	75	57 600	97 300	6 500	410	RNA4911	IR556325
	—	NA 5911	—	—	—	55	80	34	1	63	60	61	75	82 600	154 000	6 500	559	RNA5911	IR556334
	—	—	NA 6911	—	—	55	80	45	1	63	60	61	75	99 000	194 200	6 500	730	RNA6911	IR556345
60	—	—	—	—	NKI 60/25	60	82	25	0.6	68	64	66	78	54 800	116 700	6 000	395	NK68/25	IR606825
	—	—	—	—	NKI 60/35	60	82	35	0.6	68	64	66	78	72 100	165 700	6 000	560	NK68/35	IR606835
	NA 4912	—	—	—	—	60 <sup>0</sup> <sub>-0.015</sub>	85	25	1	68	64	66	80	60 100	104 900	6 000	440	RNA4912	IR606825
	—	NA 5912	—	—	—	60	85	34	1	68	65	66	80	86 100	167 000	6 000	614	RNA5912	IR606834
	—	—	NA 6912	—	—	60	85	45	1	68	65	66	80	103 000	210 800	6 000	785	RNA6912	IR606845
65	NA 4913	—	—	—	—	65	90	25	1	72	70	70.5	85	62 800	113 800	5 500	470	RNA4913	IR657225
	—	NA 5913	—	—	—	65 <sup>0</sup> <sub>-0.015</sub>	90	34	1	72	70	70.5	85	89 900	180 000	5 500	655	RNA5913	IR657234
	—	—	—	—	NKI 65/35	65	90	35	0.6	73	69	71	86	80 400	180 400	5 500	710	NK73/35	IR657335
	—	—	NA 6913	—	—	65	90	45	1	72	70	70.5	85	107 900	226 500	5 500	840	RNA6913	IR657245
	—	—	—	—	—	—	—	—	—	—	—	—	—	—	—	—	—	—	—
70	—	—	—	—	NKI 70/25	70	95	25	1	80	75	78	90	59 400	137 300	5 000	540	NK80/25	IR708025
	—	—	—	—	NKI 70/35	70	95	35	1	80	75	78	90	78 100	194 200	5 000	755	NK80/35	IR708035
	NA 4914	—	—	—	—	70 <sup>0</sup> <sub>-0.015</sub>	100	30	1	80	75	78	95	83 200	157 900	5 000	765	RNA4914	IR708030
	—	NA 5914	—	—	—	70	100	40	1	80	75	78	95	112 000	232 000	5 000	1 060	RNA5914	IR708040
	—	—	NA 6914	—	—	70	100	54	1	80	75	78	95	133 400	310 900	5 000	1 400	RNA6914	IR708054
75	—	—	—	—	NKI 75/25	75	105	25	1	85	80	83	100	76 400	145 100	4 500	675	NK85/25	IR758525
	NA 4915	—	—	—	—	75	105	30	1	85	80	83	100	86 200	169 700	4 500	810	RNA4915	IR758530
	—	—	—	—	NKI 75/35	75 <sup>0</sup> <sub>-0.015</sub>	105	35	1	85	80	83	100	102 000	209 900	4 500	945	NK85/35	IR758535
	—	NA 5915	—	—	—	75	105	40	1	85	80	83	100	116 000	249 000	4 500	1 130	RNA5915	IR758540
	—	—	NA 6915	—	—	75	105	54	1	85	80	83	100	138 300	330 500	4 500	1 480	RNA6915	IR758554
80	—	—	—	—	NKI 80/25	80	110	25	1	90	85	88	105	77 400	150 000	4 500	710	NK90/25	IR809025
	NA 4916	—	—	—	—	80	110	30	1	90	85	88	105	87 400	174 600	4 500	855	RNA4916	IR809030
	—	—	—	—	NKI 80/35	80 <sup>0</sup> <sub>-0.015</sub>	110	35	1	90	85	88	105	103 000	216 700	4 500	995	NK90/35	IR809035
	—	NA 5916	—	—	—	80	110	40	1	90	85	88	105	117 000	257 000	4 500	1 150	RNA5916	IR809040
	—	—	NA 6916	—	—	80	110	54	1	90	85	88	105	143 200	350 100	4 500	1 560	RNA6916	IR809054
85	—	—	—	—	NKI 85/26	85	115	26	1	95	90	93	110	79 700	158 900	4 200	775	NK95/26	IR859526
	—	—	—	—	NKI 85/36	85	115	36	1	95	90	93	110	106 900	230 500	4 200	1 080	NK95/36	IR859536
	NA 4917	—	—	—	—	85 <sup>0</sup> <sub>-0.020</sub>	120	35	1.1	100	91.5	98	133.5	109 800	244 200	4 000	1 280	RNA4917	IR8510035
	—	NA 5917	—	—	—	85	120	46	1.1	100	91.5	98	133.5	144 000	346 000	4 000	1 760	RNA5917	IR8510046
	—	—	NA 6917	—	—	85	120	63	1.1	100	91.5	98	133.5	172 600	466 800	4 000	2 340	RNA6917	IR8510063

\* Suitable for oil lubrication. In case of grease lubrication, down to 60% of this value.

# MACHINED RING NEEDLE ROLLER BEARINGS WITH INNER RING

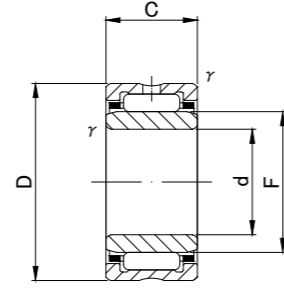
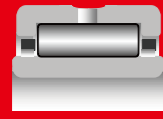

NA49,NA59,NA48,NKI

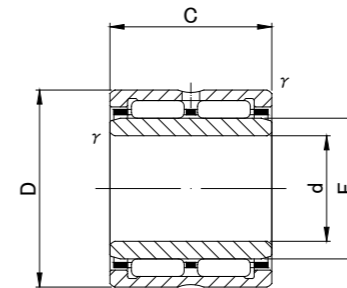

NA69

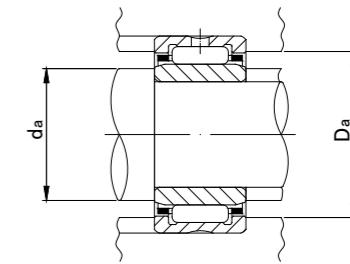

## ■ NA49,NA59,NA69,NA48,NKI TYPE

Shaft Diameter (mm)	Designation					Dimensions (mm)					Standard mounting dimensions (mm)		Basic dynamic load rating	Basic static load rating	Limiting speed*	Mass	Usable bearing designation		
	NA 49	NA 59	NA 69	NA48	NKI	d	D	C	r/s min	F	da		Da	Cr N	Cor N	rpm	g (approx)	OUTER RING	INNER RING
											MIN	MAX							
90	—	—	—	—	NKI 90/26	90	120	26	1	100	95	98	135	82 500	168 700	4 000	820	NK100/26	IR9010026
	—	—	—	—	NKI 90/36	90	120	36	1	100	95	98	135	109 800	244 200	4 000	1 140	NK100/36	IR9010036
	NA 4918	—	—	—	—	90 <sup>0</sup> <sub>-0.020</sub>	125	35	1.1	105	96.5	103	118.5	112 800	257 900	3 800	1 350	RNA4918	IR9010535
	—	NA 5918	—	—	—	90	125	46	1.1	105	96.5	103	118.5	148 000	365 000	3 800	1 840	RNA5918	IR9010546
	—	—	NA 6918	—	—	90	125	63	1.1	105	96.5	103	118.5	177 500	490 300	3 800	2 460	RNA6918	IR9010563
95	—	—	—	—	NKI 95/26	95	125	26	1	105	100	103	120	84 700	177 500	3 800	860	NK105/26	IR9510526
	—	—	—	—	NKI 95/36	95	125	36	1	105	100	103	120	112 800	257 900	3 800	1 190	NK105/36	IR9510536
	NA 4919	—	—	—	—	95 <sup>0</sup> <sub>-0.020</sub>	130	35	1.1	110	101.5	108	123.5	116 700	270 700	3 600	1 420	RNA4919	IR9511035
	—	NA 5919	—	—	—	95	130	46	1.1	110	101.5	108	123.5	152 000	384 000	3 600	1 980	RNA5919	IR9511046
	—	—	NA 6919	—	—	95	130	63	1.1	110	101.5	108	123.5	182 400	514 800	3 600	2 580	RNA6919	IR9511063
100	—	—	—	—	NKI 100/30	100	130	30	1.1	110	106.5	108	123.5	105 900	239 300	3 600	1 040	NK110/30	IR10011030
	—	—	—	—	NKI 100/40	100	130	40	1.1	110	106.5	108	123.5	133 400	323 600	3 600	1 380	NK110/40	IR10011040
	NA 4920	—	—	—	—	100	140	40	1.1	115	106.5	113	133.5	145 000	329 000	3 500	1 960	RNA4920	IR10011540
110	—	—	—	NA 4822	—	110 <sup>0</sup> <sub>-0.020</sub>	140	30	1	120	115	118	135	93 000	239 000	3 500	1 200	RNA4822	IR11012030
	NA 4922	—	—	—	—	110	150	40	1.1	125	116.5	123	143.5	152 000	357 000	3 000	2 120	RNA4922	IR11012540
120	—	—	—	NA 4824	—	120 <sup>0</sup> <sub>-0.020</sub>	150	30	1	130	125	128	145	97 000	259 000	3 000	1 300	RNA4824	IR12013030
	NA 4924	—	—	—	—	120	165	45	1.1	135	126.5	133	158.5	187 000	435 000	3 000	2 960	RNA4924	IR12013545
130	—	—	—	NA 4826	—	130 <sup>0</sup> <sub>-0.025</sub>	165	35	1.1	145	136.5	143	158.5	117 000	340 000	3 000	1 960	RNA4826	IR13014535
	NA 4926	—	—	—	—	130	180	50	1.5	150	138	148	172	216 000	540 000	2 500	4 030	RNA4926	IR13015050
140	—	—	—	NA 4828	—	140 <sup>0</sup> <sub>-0.025</sub>	175	35	1.1	155	146.5	153	168.5	121 000	363 000	2 500	2 100	RNA4828	IR14015535
	NA 4928	—	—	—	—	140	190	50	1.5	160	148	158	182	224 000	580 000	2 500	4 290	RNA4928	IR14016050
150	—	—	—	NA 4830	—	150 <sup>0</sup> <sub>-0.025</sub>	190	40	1.1	165	156.5	163	183.5	168 000	446 000	2 500	2 880	RNA4830	IR15016540
160	—	—	—	NA 4832	—	160 <sup>0</sup> <sub>-0.025</sub>	200	40	1.1	175	166.5	173	193.5	173 000	474 000	2 500	3 050	RNA4832	IR16017540

\* Suitable for oil lubrication. In case of grease lubrication, down to 60% of this value.